

Model **WT3-201**

---

WIRE CRIMP PULL TESTER

# **User's Guide**

**MARK-10**®

*Thank you...*



Thank you for purchasing a Mark-10 WT3-201 wire crimp pull tester, designed for pull test applications up to 200 lbf (1,000 N).

With proper usage, we are confident that you will get many years of great service with this product. Mark-10 instruments are ruggedly built for many years of service in laboratory and industrial environments.

This User's Guide provides setup, safety, and operation instructions. Dimensions and specifications are also provided. For additional information or answers to your questions, please do not hesitate to contact us. Our technical support and engineering teams are eager to assist you.

**Before use, each person who is to use the WT3-201 should be fully trained in appropriate operation and safety procedures.**

**TABLE OF CONTENTS**

OVERVIEW..... 2  
 POWER..... 3  
 SETUP ..... 4  
 HOME SCREEN AND CONTROLS ..... 6  
 OPERATING MODES..... 8  
 CHANGING THE UNITS..... 9  
 DIGITAL FILTERS ..... 10  
 SET POINTS ..... 11  
 BREAK DETECTION..... 12  
 DATA MEMORY AND STATISTICS ..... 14  
 COMMUNICATIONS AND OUTPUTS ..... 16  
 CALIBRATION ..... 19  
 PASSWORDS..... 23  
 OTHER SETTINGS..... 25  
 SPECIFICATIONS ..... 28

## 1 OVERVIEW

### 1.1 List of included items

Qty.	Part No.	Description
1	AC1118	Battery (inside the tester)
1	-	Certificate of calibration
1	AC1111	USB cable
1	08-1022	AC adapter body with US, EU, or UK prong
1	WT3002	Optional ring terminal fixture
1	WT3003	Optional blank fixture
1	WT3004	Optional carrying case
-	USB driver, MESUR <sup>®</sup> Lite software, MESUR <sup>®</sup> gauge evaluation software, User's Guide <b>Download at: <a href="http://www.mark-10.com/resources">www.mark-10.com/resources</a></b>	

### 1.2 Safety / Proper Usage

#### Caution!

**Note the tester's capacity of 200 lbF [1,000 N]. Producing a force greater than 150% of capacity can damage the internal load cell. An overload can occur whether the tester is powered on or off.**

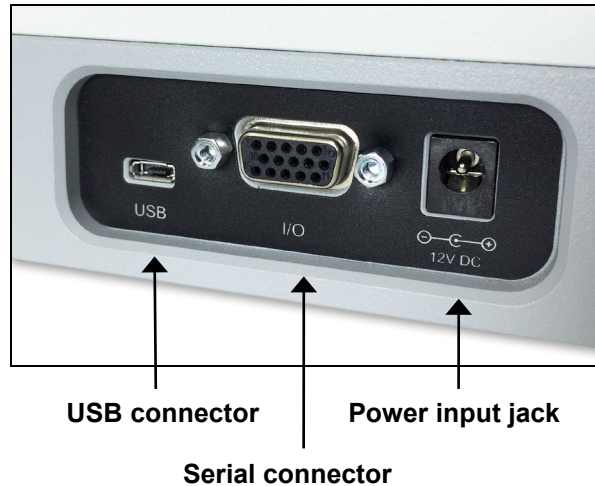
Typical materials able to be tested include many manufactured items, such as wires, tubing, and other samples. Items that should not be used with the tester include potentially flammable substances or products, items that can shatter in an unsafe manner, and any other components that can present an exceedingly hazardous situation when acted upon by a force.

The following safety checks and procedures should be performed before and during operation:

1. Never operate the tester if there is any visible damage to the AC adapter or the tester itself.
2. Ensure that the tester is kept away from water or any other electrically conductive liquids at all times.
3. The tester should be serviced by a trained technician only. AC power must be disconnected and the tester must be powered off before the housing is opened.
4. Always consider the characteristics of the sample being tested before initiating a test. A risk assessment should be carried out beforehand to ensure that all safety measures have been addressed and implemented.
5. Wear eye and face protection when testing, especially when testing brittle samples that have the potential to shatter under force. Be aware of the dangers posed by potential energy that can accumulate in the sample during testing. Extra bodily protection should be worn if a destructive failure of a test sample is possible.
6. In certain applications, such as the testing of brittle samples that can shatter, or other applications that could lead to a hazardous situation, it is strongly recommended that a machine guarding system be employed to protect the operator and others in the vicinity from shards or debris.
7. When the tester is not in use, ensure that the power is turned off.


## 2 POWER

The tester is powered either by an 8.4V NiMH rechargeable battery or by an AC adapter. Since these batteries are subject to self discharge, it may be necessary to recharge the unit after a prolonged period of storage. Plug the accompanying charger into the AC outlet and insert the charger plug into the receptacle on the tester (refer to the illustration below). The battery will fully charge in approximately 8 hours.







### Caution!

**Do not use chargers or batteries other than supplied or instrument damage may occur.**

If the AC adapter is plugged in, an icon appears in the lower left corner of the display, as follows: 

If the AC adapter is not plugged in, battery power drainage is denoted in a five-step process:

1. When battery life is greater than 75%, the following indicator is present: 
2. When battery life is between 50% and 75%, the following indicator is present: 
3. When battery life is between 25% and 50%, the following indicator is present: 
4. When battery life is less than 25%, the following indicator is present: 
5. When battery life drops to approximately 2%, the indicator from step 4 will be flashing. Several minutes after (timing depends on usage and whether the backlight is turned on or off), a message appears, "BATTERY VOLTAGE TOO LOW. POWERING OFF". A 4-tone audio indicator will sound and the tester will power off.

The tester can be configured to automatically power off following a period of inactivity. Refer to the **Other Settings** section for details.

If battery replacement is necessary, the battery may be accessed by removing the sheet metal cover on the underside of the base.

## 3 SETUP

### 3.1 Mechanical Setup

#### 3.1.1 Assembly

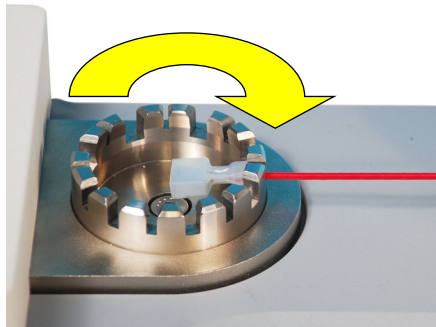
The lever is shipped disassembled from the unit to prevent damage in transit. To install, match the pin on the cam mechanism with the corresponding blind hole in the lever hub. Then, tighten the plastic knob into the threaded hole in the lever hub.

#### 3.1.2 Mounting

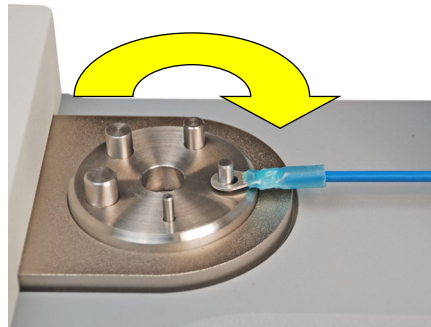
Place the tester on a clean, flat and level work area free from vibration. If desired, the tester can be secured to the work area with four 1/4-20 screws fastened into the underside of the base.

#### 3.1.3 Sample setup

1. Secure the terminal into the standard terminal fixture or optional ring terminal fixture, as shown in the figures below. Index the fixtures until the desired slot or ring size is aligned with the cam mechanism adjacent to the lever. The fixtures will click when indexing to each size selection.

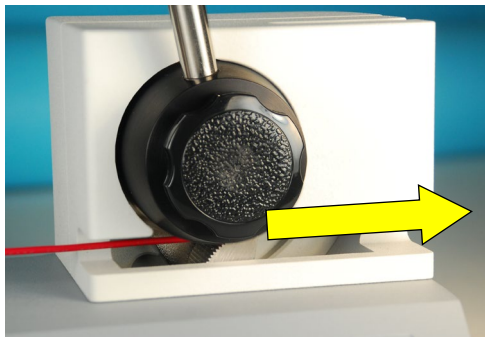


**Fig. 3.1**  
Wire terminal fixture



**Fig. 3.2**  
Ring terminal fixture (optional)

2. Rotate the lever clockwise until its end of travel.
3. Insert the loose end of the wire between the cams in the mechanism adjacent to the lever, as shown in the figure below. Keep the wire taut as it is inserted.



**Fig. 3.3**  
Cam mechanism

4. Rotate the lever counter-clockwise to engage the loose end of the wire, as shown in the figure below. Continue rotating to produce force on the sample. The lever will reach its end of travel before contacting the keypad / display housing.



**Fig. 3.4**  
Rotating the lever

5. When the test is complete, rotate the lever clockwise until the end of travel. The cams will open and the wire will be released.

#### 3.1.4 Installing the ring terminal fixture

To install or uninstall the standard terminal fixture or optional ring terminal fixture, loosen the screw in the center of the fixture, remove, place the other fixture in the receptacle, and re-tighten the screw.

#### 3.2 Installing the USB driver

If communicating via USB, install the USB driver available at: [www.mark-10.com/resources](http://www.mark-10.com/resources)

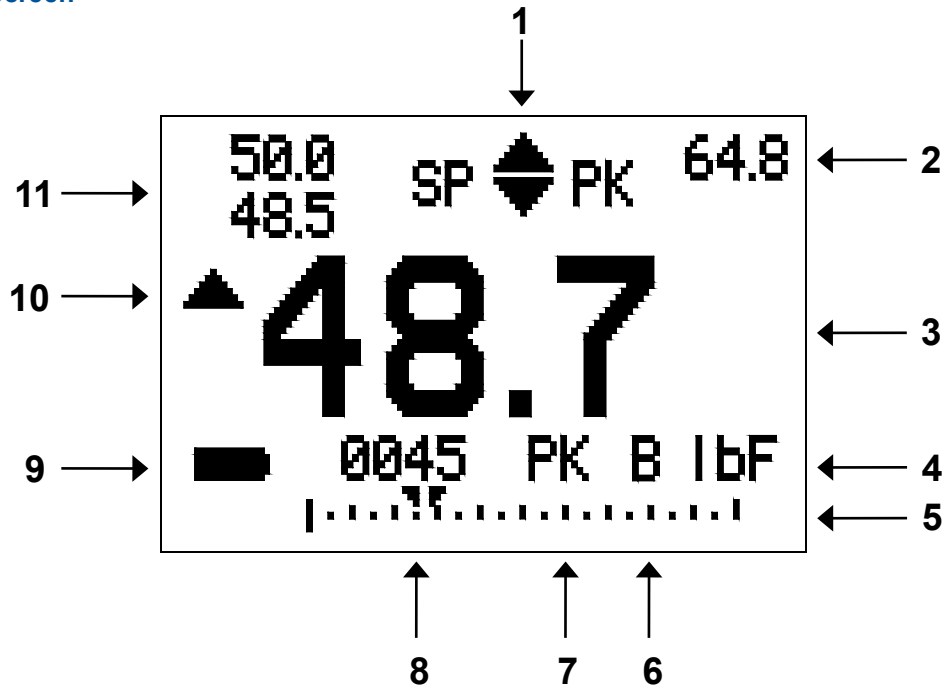
#### **Caution!**

***Install the USB driver before physically connecting the gauge to a PC with the USB cable.***

Further instructions for configuring and using the gauge's outputs are provided in the **Communications and Outputs** section.




## 4 HOME SCREEN AND CONTROLS

### 4.1 Home Screen



No.	Name	Description
1	<b>Tension indicator</b>	This symbol indicates that a tension (pull) load is occurring. When this symbol is not present, either no load is occurring, or a compression load is occurring.
2	<b>Peak</b>	The maximum measured tension force. This reading can be reset by pressing <b>ZERO</b> or by powering the tester off and on.
3	<b>Primary reading</b>	The current displayed reading. See <b>Operating Modes</b> section for details.
4	<b>Units</b>	The current measurement unit. Abbreviations are as follows: lbF – Pound-force ozF – Ounce-force kgF – Kilogram-force N – Newton kN – Kilonewton
5	<b>Load bar</b>	Analog indicator to help identify when an overload condition is imminent. The bar increases from left to right, indicating increasing load. If set points are enabled, triangular markers are displayed for visual convenience. This indicator reflects the actual load, which may not correspond to the primary reading (depends on operating mode). The <b>ZERO</b> key does not reset the load bar. See <b>Operating Modes</b> section for details.
6	<b>Break Detection On/Off</b>	The letter “B” appears if the Break Detection function is enabled. Refer to the <b>Break Detection</b> section for details.
7	<b>Mode</b>	The current measurement mode. Abbreviations are as follows: RT – Real Time PK – Peak See <b>Operating Modes</b> section for details about each of these modes
8	<b>Number of stored data points</b>	The number of stored data points in memory, up to 1000. Displayed only if <b>Memory Storage</b> is enabled for the <b>DATA</b> key.
9	<b>Battery / AC adapter indicator</b>	Either the AC adapter icon or battery power icon will be shown, depending on power conditions. Refer to the <b>Power</b> section for details.
10	<b>High / low limit indicators</b>	Correspond to the programmed set points. Indicator definitions are as follows: ▲ – the displayed value is greater than the upper force limit ■ – the displayed value is between the limits ▼ – the displayed value is less than the lower force limit
11	<b>Set points</b>	The programmed force limits. Typically used for pass/fail type testing. 1, 2, or no indicators may be present, depending on the configuration shown in the <b>Set Points</b> menu item.

## 4.2 Controls

Primary Label	Primary Function	Secondary Label	Secondary Function
	Powers the tester on and off. Press briefly to power on, press and hold to power off. Active only when the home screen is displayed.	<b>ENTER</b>	Various uses, as described in the following sections.
<b>ZERO</b>	Zeroes the primary reading and peaks.	 <b>(UP)</b>	Navigates up through the menu and sub-menus.
<b>MENU</b>	Enters the main menu.	<b>ESCAPE</b>	Reverts one step backwards through the menu hierarchy.
<b>MODE</b>	Toggles between measurement modes.	 <b>(DOWN)</b>	Navigates down through the menu and sub-menus.
<b>DATA</b>	Stores a value to memory, transmits the current reading to an external device, and/or initiates automatic data output, depending on setup.	<b>DELETE</b>	Enables and disables <b>Delete</b> mode while viewing stored data.

## 4.3 Menu navigation basics

Most of the tester's various functions and parameters are configured through the main menu. To access the menu press **MENU**. Use the **UP** and **DOWN** keys to scroll through the items. The current selection is denoted with clear text over a dark background. Press **ENTER** to select a menu item, then use **UP** and **DOWN** again to scroll through the sub-menus. Press **ENTER** again to select the sub-menu item.

For parameters that may be either selected or deselected, press **ENTER** to toggle between selecting and deselecting. An asterisk (\*) to the left of the parameter label is used to indicate when the parameter has been selected.

For parameters requiring the input of a numerical value, use the **UP** and **DOWN** keys to increment or decrement the value. Press and hold either key to auto-increment at a gradually increasing rate. When the desired value has been reached, press **ENTER** to save the change and revert back to the sub-menu item, or press **ESCAPE** to revert back to the sub-menu item without saving. Press **ESCAPE** to revert one step back in the menu hierarchy until back into normal operating mode.

Refer to the following sections for details about setting up particular functions and parameters.



## 5 OPERATING MODES

---

### Caution!

In any operating mode, if the capacity of the tester has been exceeded by more than 110%, the display will show "OVER" to indicate an overload. A continuous audible tone will be sounded until the MENU key has been pressed or the load has been reduced to a safe level.

Three operating modes are possible with the WT3-201. To cycle between the modes, press **MODE** while in the home screen.

#### 5.1 Real time (RT)

The primary reading corresponds to the live measured reading.

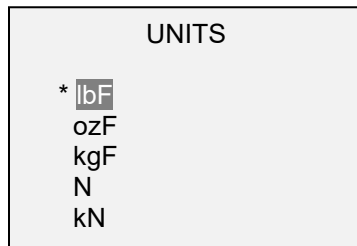
#### 5.2 Peak (PK)

The primary reading corresponds to the peak tension reading observed. If the actual force decreases from the peak value, the peak will still be retained in the primary reading area of the display. Pressing **ZERO** will reset the value.

## 6 CHANGING THE UNITS

---

The WT3-201 can display five different measurement units. To change the unit, select **Units** from the menu. The display will list the available units, as follows:



The tester will always power on with the unit selected in this sub-menu.

## 7 DIGITAL FILTERS

---

Digital filters are provided to help smooth out the readings in situations where there is mechanical interference in the work area or test sample. These filters utilize the moving average technique in which consecutive readings are pushed through a buffer and the displayed reading is the average of the buffer contents. By varying the length of the buffer, a variable smoothing effect can be achieved. The selection of 1 will disable the filter since the average of a single value is the value itself.

To access digital filter settings, select **Filters** from the menu. The display appears as follows:



Two filters are available:

**Current Reading** – Applies to the peak capture rate of the instrument.

**Displayed Reading** – Applies to the primary reading on the display.

Available settings: 1, 2, 4, 8, 16, 32, 64, 128, 256, 512, 1024. It is recommended to keep the current reading filter at its lowest value for best performance, and the displayed reading filter at its highest value for best stability.

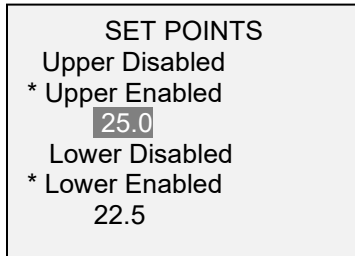
## 8 SET POINTS

### 8.1 General Information

Set points are useful for tolerance checking (pass/fail), triggering an external device such as an indicator or alarm in process control applications. Two limits, high and low, are specified and stored in the non-volatile memory of the instrument and the primary reading is compared to these limits. The results of the comparisons are indicated through the three outputs provided on the 15-pin connector, thus providing “under”, “in range”, and “over” signaling. These outputs can be connected to indicators, buzzers, or relays as required for the application.

### 8.2 Configuration

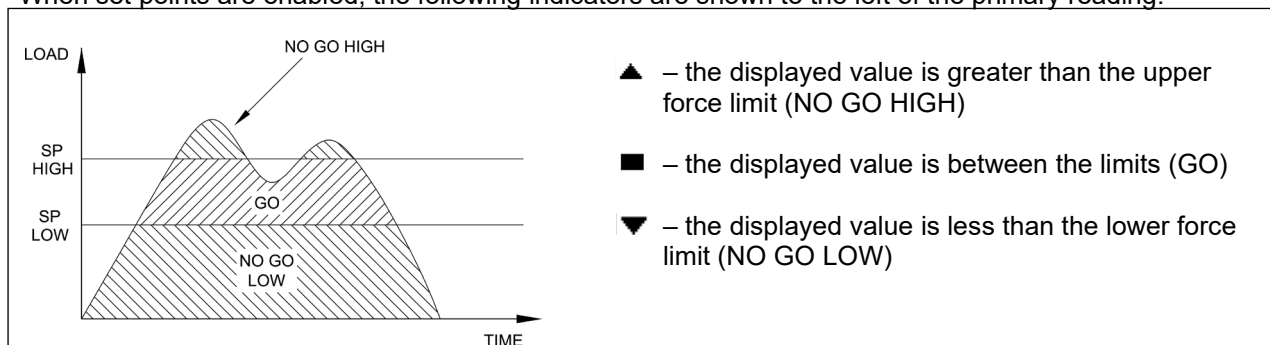
To configure set points, select **Set Points** from the menu. The screen appears as follows:



Either one, two, or none of the set points may be enabled.

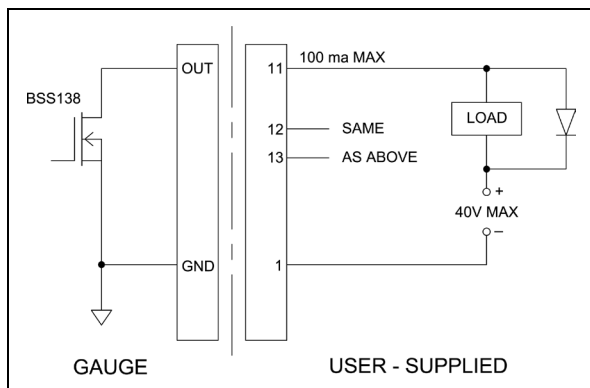
If two set points have been enabled, they are displayed in the upper left corner of the display. If only one set point has been enabled, the word “OFF” appears in place of the value. If no set points have been enabled, the upper left corner of the display will be blank.

When set points are enabled, the following indicators are shown to the left of the primary reading:



**Note:** Set point indicators and outputs reference the displayed reading, not necessarily the current live load.

#### 8.2.1 Set Point Outputs Schematic Diagram



## 9 BREAK DETECTION

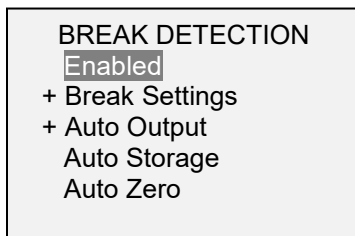
The break detection function identifies when the termination has been removed from the wire, or other applications in which the force value has reached a peak, then dropped. Upon detection of the break, the tester can perform several automatic functions, as follows:

1. Transmit the peak reading (Auto Output).
2. Save the peak value to memory (Auto Storage).
3. Zero the primary and peak readings (Auto Zero).
4. Toggle a pin.

Break detection functions and settings are configured from a central location, and apply to any mode in which it is enabled. Refer to the **Operating Modes** section for details on configuring each mode.

### 9.1 Configuration

To enable Break Detection and configure the automatic functions, select **Break Detection** from the main menu. The display appears as follows:



Any combination of the above functions may be selected.

Function	Description
<b>Enabled</b>	Arms the break detection function. When enabled, the letter "B" appears on the home screen, between the Mode and Unit indicators. Refer to the <b>Home Screen and Controls</b> section for details.
<b>Break Settings</b>	Refer to the following sub-sections for details.
<b>Auto Output</b>	
<b>Auto Storage</b>	Automatically stores the peak reading to memory.
<b>Auto Zero</b>	Automatically zeroes the display following data transmission and/or storage. A time delay may be configured in <b>Break Detection Settings</b> . Refer to the next sub-section for details.

If tones are enabled, a tone will sound when the output, storage, and zero functions have occurred.

### 9.2 Break Settings

Select **Break Settings** from the **Break Detection** menu to configure the settings. The display appears as follows:

BREAK DETECTION SETTINGS	
Threshold:	5 %
% Drop:	50 %
Auto Zero Delay	5 sec.

<b>Threshold</b>	Sets the percentage of full scale at which the break detection function becomes active. This threshold is provided to ignore peaks that can occur during sample loading and unloading. <i>Available settings: -90%, in 1% increments until 5%, 5% increments thereafter.</i>
<b>% Drop</b>	Sets the percentage drop from the peak reading at which the break is detected. <i>Available settings: 5%–90% in 5% increments.</i>
<b>Auto Zero Delay</b>	Sets the time delay before the primary and peak readings are zeroed. Auto zero can be disabled if required. Refer to the <b>Auto Output Settings</b> sub-section for details. <i>Available settings: 1–10 sec. in 1 sec. increments, and 10–60 sec. in 5 sec. increments.</i>

### 9.3 Auto Output Settings

Scroll to **Auto Settings** in the **Break Detection** menu and press **ENTER** to configure the auto output settings. Any combination may be selected. The display appears as follows:

AUTO OUTPUT SETTINGS	
<b>RS232/USB Output</b>	
<b>Mitutoyo Output</b>	
<b>Output Pin:</b>	NONE

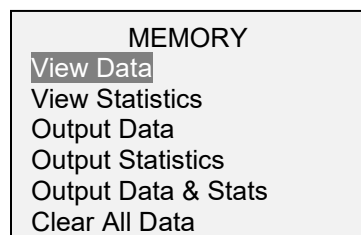
Parameter	Description
<b>RS232/USB Output</b>	Automatically output the peak when the break (% Drop) is detected.
<b>Mitutoyo Output</b>	Automatically output the peak when the break (% Drop) is detected.
<b>Output Pin</b>	Automatically toggle the SP1, SP2, or SP3 pins (active low). If not required, select "NONE".

## 10 DATA MEMORY AND STATISTICS

The WT3-201 has storage capacity of 1,000 data points. Readings may be stored, viewed, and output to an external device. Individual, or all, data points may be deleted. Statistics are calculated for the data presently in memory.

To enable memory storage, select **DATA Key** from the menu, then scroll to **Memory Storage** and press **ENTER**. Then exit the menu. In the home screen, the data record number **0000** appears below the primary reading. Press **DATA** at any time to save the displayed reading. The record number will increment each time **DATA** is pressed. If **DATA** is pressed when memory is full the message "MEMORY FULL" will be flashed at the bottom of the display and a double audio tone will be sounded.

To view, edit, and output stored readings and statistics, select **Memory** from the menu. The screen appears as follows:



### 10.1 View Data

All the saved data points may be viewed. The record number is displayed, along with the corresponding value and presently set unit of measurement. Any readings may be deleted individually. To do so, scroll to the desired reading and press **DELETE**. The letter "D" appears to the left of the record number, indicating that the tester is in **Delete** mode, as follows:

0001	24.8 lbF
0002	22.2 lbF
0003	24.6 lbF
0004	18.9 lbF
D 0005	20.0 lbF
0006	19.9 lbF
0007	20.2 lbF

Press **ENTER** to delete the value. To exit **Delete** mode, press **DELETE** again. Any number of readings may be individually deleted, however, all readings may also be cleared simultaneously. Refer to the **Clear All Data** section for details.

### 10.2 Statistics

Statistical calculations are performed for the saved values. Calculations include number of readings, minimum, maximum, mean, and standard deviation.

### 10.3 Output Data

Press **ENTER** to output data to an external device. The display will show, "SENDING DATA...", then "DATA SENT". If there was a problem with communication, the display will show, "DATA NOT SENT". Saved data can be downloaded by Mark-10 data collection programs. Refer to their respective user's guides for details.

### 10.4 Output Statistics

Press **ENTER** to output statistics to an external device. The display will show, "SENDING STATS...", then "STATS SENT". If there was a problem with communication, the display will show, "STATS NOT SENT".

### 10.5 Output Data & Stats

Press **ENTER** to output data and statistics to an external device. The display will show, "SENDING DATA", then "SENDING STATS...", then "DATA SENT", then "STATS SENT". If there was a problem with communication, the display will show, "DATA NOT SENT" and/or "STATS NOT SENT".

### 10.6 Clear All Data

Press **ENTER** to clear all data from the memory. A prompt will be shown, "CLEAR ALL DATA?". Select **Yes** to clear all the data, or **No** to return to the sub-menu.

For output of data and/or statistics, RS-232 or USB output must be enabled. Data formatting is <CR><LF> following each value. Units can be either included or excluded. Output of data via the Mitutoyo output is possible, however, output of statistics is not. Refer to the **Communications and Outputs** section for details.

**Note:** Data is not retained while the gauge is powered off. However, the gauge protects against accidental or automatic power-off. If manually powering the instrument off, or if the inactivity time limit for the **Automatic Shutoff** function has been reached, the following warning message appears:



If no option is selected, this screen will be displayed indefinitely, or until battery power has been depleted.

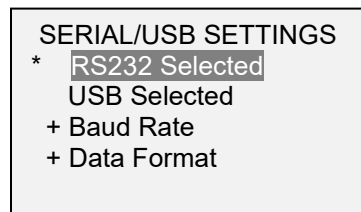


## 11 COMMUNICATIONS AND OUTPUTS

Communication with the WT3-201 tester is achieved through the micro USB or 15-pin serial ports, as shown in the illustration in the **Power** section. Communication is possible only when the tester is in the main operating screen (i.e. not in a menu or configuration area).

### 11.1 Serial / USB

To set up RS-232 and USB communication, select **Serial/USB Settings** from the menu. The display appears as follows:



Select either RS-232 or USB input (output is always simultaneous through both the USB and RS-232 ports). Communication settings are permanently set to the following:

**Data Bits:** 8  
**Stop Bits:** 1  
**Parity:** None

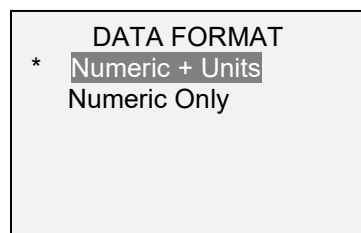
Other settings are configured as follows:

#### 11.1.1 Baud Rate

Select the baud rate as required for the application. It must be set to the same value as the receiving device.

#### 11.1.2 Data Format

Select the desired data format. The display appears as follows:



Selection	Description
Numeric + Units	Output format includes the value and unit of measure.
Numeric Only	Output format includes the value only.

#### 11.1.3 Data Communication

Individual data points may be transmitted by pressing **DATA**. The WT3-201 may also be controlled by an external device through the RS-232 or USB channels. The following is a list of supported commands and their explanations. All commands must be terminated by a CR (Carriage Return) character, 0x0D, or a CR-LF (Carriage Return – Line Feed) pair, where the Line Feed, 0x0A, is ignored.

?	Request the displayed reading
MEM	Transmit all stored readings
STA	Transmit statistics
CLRMEM	Delete all stored readings from memory

### 11.1.4 Command Responses

In response to the reading request command '?' the tester will return a string with the load data, followed by a space, then the load unit (if enabled, as described above). It will be terminated by a CR-LF pair.

Example return string:

124.8 lbF<CR><LF> 124.8 lbF of pull force

Any detected errors are reported back by means of error code \*10 (illegal command).

### 11.2 Mitutoyo BCD settings

This output is useful for connection to data collectors, printers, multiplexers, or any other device capable of accepting Mitutoyo BCD data. Individual data points may be transmitted by pressing **DATA** or by requesting it from the Mitutoyo communication device (if available). To enable Mitutoyo output, make the appropriate selection. The screen appears as follows:

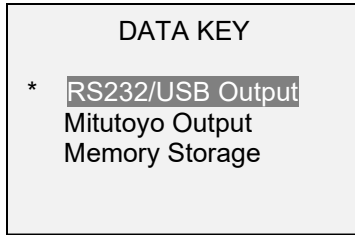


### 11.3 Analog Output

This output can be used for chart recorders, oscilloscopes, data acquisition systems, or any other compatible devices with analog inputs. The output produces  $\pm 1$  volt at full scale of the instrument. Note that the polarity of the signal is negative.

### 11.4 DATA Key Functions

The **DATA** key can be configured to perform several functions. To configure the **DATA** key, select **DATA Key** from the menu. The display appears as follows:

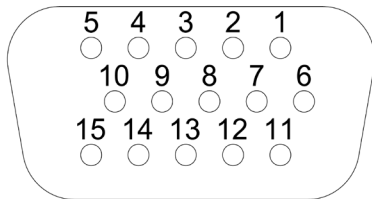


Three options are available:

Selection	Function when pressing DATA
<b>RS232/USB Output</b>	Outputs data via the serial and USB ports
<b>Mitutoyo Output</b>	Outputs data via Mitutoyo (Digimatic) through the serial port
<b>Memory Storage</b>	Stores a reading to memory (refer to the <b>Memory</b> section for details)

Any combination of the above functions may be selected.

### 11.5 I/O Connector Pin Diagram (DB-15HD female)



Pin No.	Description	Input / Output
1	Signal Ground	---
2 *	Tension Overload *	Output *
3	RS-232 Receive	Input
4	RS-232 Transmit	Output
5	+12V DC	Input / Output
6	Analog Output	Output
7 *	Compression Overload *	Output *
8	Mitutoyo Clock or Output Bit 2 (mutually exclusive)	Output
9	Mitutoyo Data or Output Bit 0 (mutually exclusive)	Output
10	Mitutoyo Request or Input Bit 3 (mutually exclusive)	Input
11	Set Point Pin 1 (SP1)	Output
12	Set Point Pin 2 (SP2)	Output
13	Set Point Pin 3 (SP3)	Output
14	External Trigger	Input
15 *	Mitutoyo Ready or Output Bit 1 (mutually exclusive) *	Output *

\* Maximum voltage: 40V.

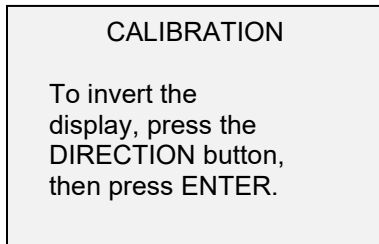
## 12 CALIBRATION

### 12.1 Initial Physical Setup

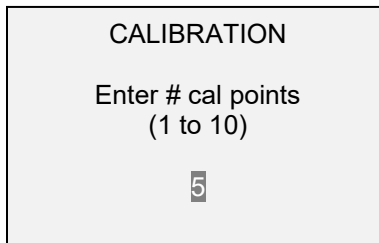
The tester should be mounted vertically to a test stand or fixture rugged enough to withstand a load equal to the full capacity of the instrument. The lever mechanism should be removed. Certified deadweights or master load cells should be used, along with appropriate mounting brackets and fixtures. A calibration kit is available from Mark-10. Caution should be taken while handling such equipment.

### 12.2 Calibration Procedure

1. Select **Calibration** from the menu. The display appears as follows:



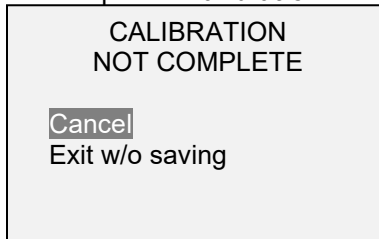
2. Press **DIRECTION** to invert the display, if desired. **ENTER** to continue. The display appears as follows:



The tester can be calibrated at up to 10 points. Enter the number of calibration points (at least one point must be selected).

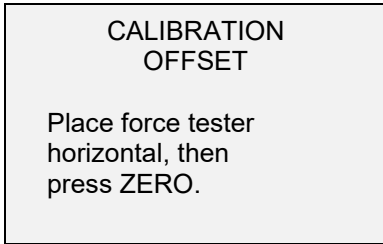
**Note:** To achieve the accuracy specification of  $\pm 0.2\%$ , it is recommended to calibrate the tester at 5 or more evenly spaced increments, such as 40, 80, 120, 160, and 200 lb loads.

3. To escape the **Calibration** menu at any time, press **ESCAPE**. The display appears as follows:

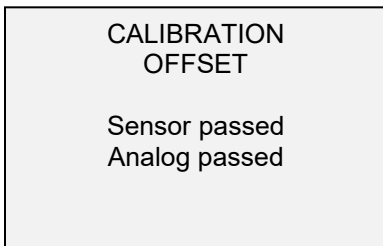
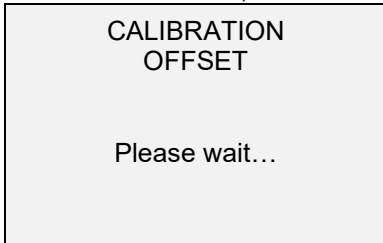


Selecting "Cancel" will revert back to the Calibration setup. Selecting "Exit w/o saving" will return to the menu without saving changes.

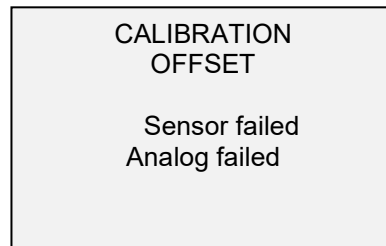
- After the number of calibration points has been entered, press **ENTER**. The display appears as follows:



- Place the tester horizontally on a level surface free from vibration, then press **ZERO**. The tester will calculate offsets, and the display appears as follows:



If failed:

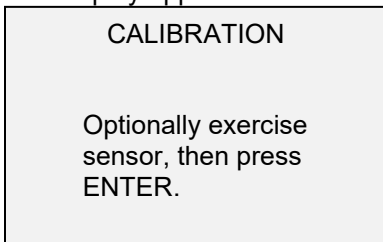


- The following screen appears after the offsets have been calculated:



Attach weight fixtures (brackets, hooks, etc), as required. Do not yet attach any weights or apply any calibration loads. Then press **ENTER**.

- The display appears as follows:



Optionally exercise the load cell several times (at full scale, if possible), then press **ENTER**.

- The display appears as follows:

CALIBRATION

Gain adjust  
Apply full scale load  
200.0 lbF +/-20%,  
then press ENTER.

Apply a weight equal to the full scale of the instrument, then press **ENTER**.

9. After displaying "Please wait..." the display appears as follows:

CALIBRATION

Ensure no load,  
then press ZERO.

Remove the load, leave the fixtures in place, then press **ZERO**.

10. The display appears as follows:

CALIBRATION

Apply load  
1 OF 5  
Enter load:  
40.0 lbF  
Press ENTER.

Use the **UP** and **DOWN** keys to adjust the load value as required. The load values default to evenly spaced increments, as indicated by the previously entered number of data points. Apply the calibration load. Then press **ENTER**.

Repeat the above step for the number of data points selected.

11. After all the calibration points have been completed, the display appears as follows:

CALIBRATION  
COMPLETE

Save & exit  
Exit w/o saving

To save the calibration information, select "Save & exit". To exit without saving the data select "Exit w/o saving".

12. Any errors are reported by the following screens:

CALIBRATION  
Units must be lbF.  
Please try again  
Press ENTER.

Displayed at the start of calibration if a disallowed unit is selected.

CALIBRATION  
Load not stable.  
Please try again.

Ensure that the load is not swinging, oscillating, or vibrating in any manner. Then try again.

CALIBRATION  
COMPRESSION  
Load too low.  
Please try again.

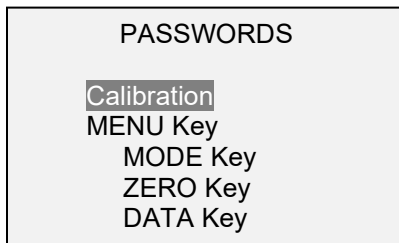
The calibration weight does not match the set value.

CALIBRATION  
Load too close  
to previous.  
Please try again.

The entered calibration point is too close to the previous point.

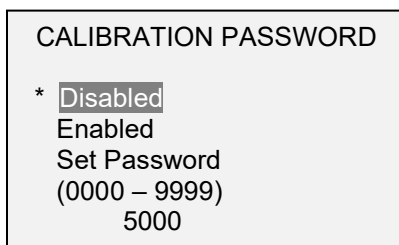
## 13 PASSWORDS

Two separate passwords may be set to control access to the Calibration section and to the menu and other keys. To access the passwords setup screen, select **Passwords** from the menu. The display appears as follows:



### 13.1 Calibration Password

Select **Calibration** from the sub-menu. The display appears as follows:



To set the password, select **Enabled**, then **Set Password**. Use the **UP** and **DOWN** keys to increment and decrement the value, from 0 to 9999. When the desired value has been selected, press **ENTER**, then **ESC** to exit the sub-menu.

### 13.2 Menu Key Password

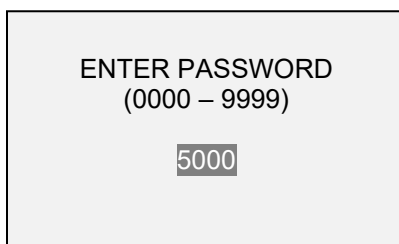
If enabled, every time the **MENU** key is selected, a password must be provided. Select **Menu Key** from the sub-menu. Follow the same procedure as described in the previous sub-section.

### 13.3 Locking Out Other Keys

Other keys may be locked out individually. Select any combination of keys (**MODE**, **ZERO**, **DATA**) by pressing **ENTER** in the **Passwords** sub-menu. Pressing a locked key will prompt the message "KEY PROTECTED" and then revert to the previous screen.

### 13.4 Password Prompts

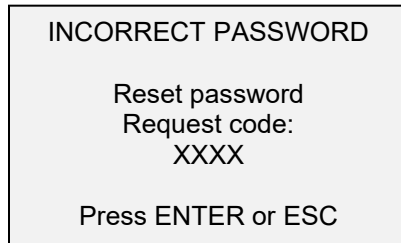
If passwords have been enabled, the following will be displayed when pressing the **MENU** key or accessing the **Calibration** section:



Use the **UP** and **DOWN** keys to select the correct password, then press **ENTER** to continue.



If the incorrect password has been entered, the display appears as follows:



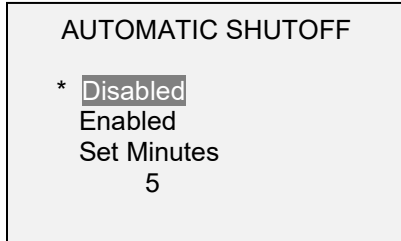
To re-enter the password, press ESC to exit to the home screen. Then, access the desired function and enter the password again when prompted.

If the password has been misplaced, it can be reset. Press **ENTER** to generate a *request code*. The *request code* must be supplied to Mark-10 or a distributor, who will then provide a corresponding *authorization code*. Enter the *activation code* to disable the password.

## 14 OTHER SETTINGS

### 14.1 Automatic Shutoff

The tester may be configured to automatically power off following a period of inactivity while on battery power. Inactivity is defined as the absence of any key presses or load changes of 100 counts or less. To access these settings, select **Automatic Shutoff** from the menu. The display appears as follows:



Select **Disabled** to disable automatic shutoff. Select **Enabled** to enable it. The length of time of inactivity is programmed in minutes via the **Set Minutes** parameter. Available settings: 5-30, in 5 minute increments.

**Note:** If the AC adapter is plugged in, the tester will ignore these settings and remain powered on until the **POWER** key is pressed.

### 14.2 Backlight

Although the backlight may be turned on and off at any time by pressing the **BACKLIGHT** key, there are several available initial settings (applicable upon powering on the tester). To access these settings, select **Backlight** from the menu. The display appears as follows:



Selection	Description
<b>Off</b>	Backlight to be off upon powering on the tester.
<b>On</b>	Backlight to be on upon powering on the tester.
<b>Auto</b>	Backlight to be on upon powering tester, but will shut off after a period of inactivity (as defined in the <b>Automatic Shutoff</b> sub-section). The backlight will turn on again when activity resumes. The length of time of inactivity is programmed in minutes via the <b>Set Minutes</b> parameter. Available settings: 1-10, in 1 minute increments.

**Note:** If the AC adapter is plugged in, the tester will ignore these settings and keep the backlight on, unless the **BACKLIGHT** key is pressed. Selecting the **On** or **Off** setting in the **Backlight** menu will manually turn the backlight on or off as if the Backlight button were pressed.

### 14.3 LCD Contrast

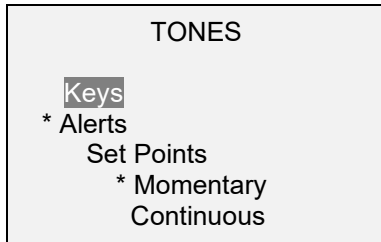
The contrast of the display may be adjusted. Select **LCD Contrast** from the menu. The screen appears as follows:



Press **ENTER** to modify the contrast. Select a value from 0 to 25, 25 producing the most contrast.

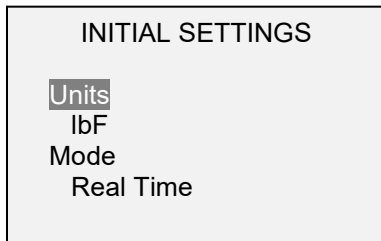
### 14.4 Tones

Audible tones can be enabled for all key presses and alerts, such as overload, set point value reached, etc. The Set Point alert can be configured to be either a momentary tone or a continuous tone (until the load is restored to a value between the set points). To configure the functions for which audible tones will apply, select **Tones** from the menu. The screen appears as follows:



### 14.5 Initial settings

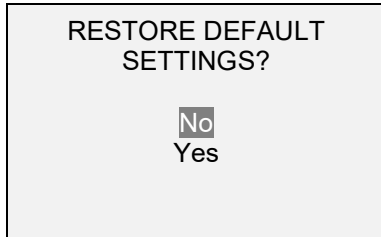
This section is used to configure the initial settings upon powering on the tester. The initial units of measurement and the primary reading measurement mode may be configured. To access these settings, select **Initial Settings** from the menu. The screen appears as follows:



The default values are lbF and Real Time.

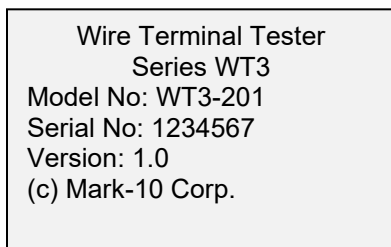
### 14.6 Restore Default Settings

Default factory settings can be restored by selecting **Restore Defaults** from the menu. The settings may be found in the **Specifications** section. The display appears as follows:



### 14.7 Information / Welcome Screen

The following screen is displayed at power up and can be accessed at any time by selecting **Information** from the menu:



## 15 SPECIFICATIONS

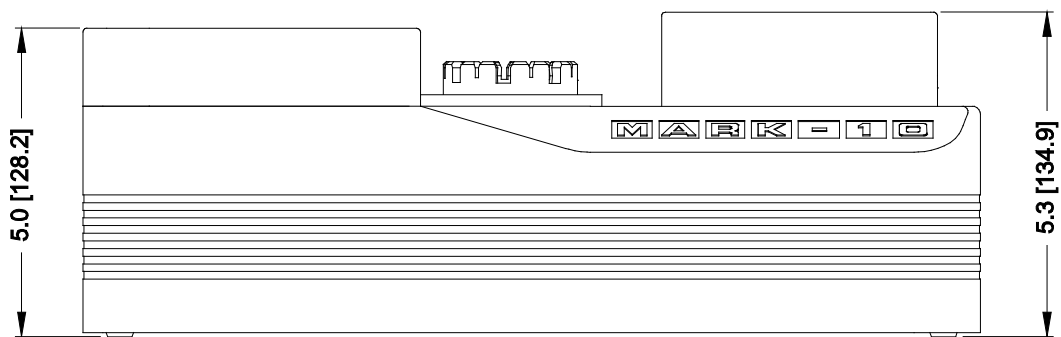
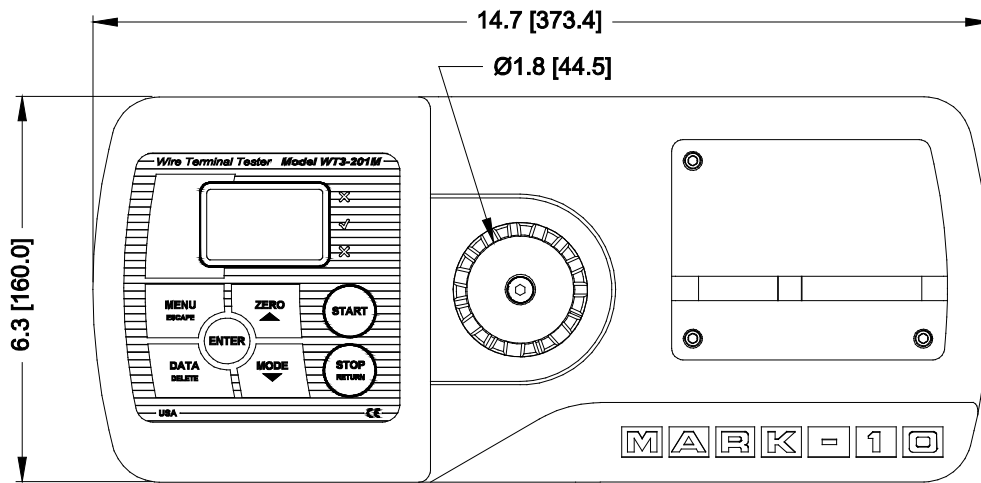
### 15.1 General

<b>Force Capacity:</b>	200 x 0.1 lbF   3200 x 2 ozF   100 x 0.05 kgF   1000 x 0.5 N   1 x 0.0005 kN
<b>Accuracy:</b>	±0.2% of full scale
<b>Wire diameter range:</b>	AWG30 - AWG 3 [0.01 - 0.25 in (0.3 - 6.3 mm)]
<b>Min. sample length:</b>	6.50 in [165 mm], excluding termination
<b>Max. elongation:</b>	1.15 in [29.2 mm]
<b>Sampling rate:</b>	7,000 Hz
<b>Power:</b>	AC or rechargeable battery. Low battery indicator appears when battery level is low, and tester powers off automatically when power reaches critical stage.
<b>Battery life:</b>	<b>Backlight on:</b> up to 7 hours of continuous use <b>Backlight off:</b> up to 24 hours of continuous use
<b>Outputs:</b>	<b>USB / RS-232:</b> Fully configurable up to 115,200 baud. Includes Tester Control Language 2 for full computer control. <b>Mitutoyo (Digimatic):</b> Serial BCD suitable for all Mitutoyo SPC-compatible devices. <b>Analog:</b> ±1 VDC, ±0.25% of full scale at capacity, <b>General purpose:</b> Three open drain outputs, one input. <b>Set points:</b> Three open drain lines.
<b>Safe overload:</b>	150% of full scale (display shows "OVER" at 110% and above)
<b>Weight:</b>	16.1 lb [7.3 kg]
<b>Included accessories:</b>	Universal voltage AC adapter, battery, quick-start guide, and NIST-traceable certificate of calibration with data.
<b>Environmental requirements:</b>	40 - 100°F, max. 93% humidity, non-condensating
<b>Warranty:</b>	3 years (see individual statement for further details)
<b>Literature &amp; Software:</b>	<b>Download at:</b> <a href="http://www.mark-10.com/resources">www.mark-10.com/resources</a>

## 15.2 Factory Settings

Parameter	Setting
Set points	
Upper	Disabled (defaults to 80% of full scale when enabled)
Lower	Disabled (defaults to 40% of full scale when enabled)
Filters	
Current	8
Displayed	512
DATA Key Functions	
RS-232/USB Output	Enabled
Mitutoyo Output	Disabled
Memory Storage	Enabled
Backlight	Auto
Minutes	1
Serial/USB	
RS-232 Output Selected	Enabled
USB Output Selected	Disabled
Baud Rate	9,600
Data Format	Numeric + units
Mitutoyo BCD Output	Disabled
Break Detection	Disabled
Threshold	5% of full scale
% Drop	50% of peak
Auto Zero Delay	5 sec.
Auto Output Settings	All disabled
Auto Storage	Disabled
Auto Zero	Disabled
Automatic Shutoff	Enabled
Minutes	5
Tones	
Keys	Enabled
Alerts	Enabled
Set Points	Momentary
Initial Settings	
Units	lbF
Mode	Real Time
Passwords	All passwords disabled

15.3 Dimensions (IN [MM])



**NOTES:**





*Mark-10 Corporation has been an innovator in the force and torque measurement fields since 1979. We strive to achieve 100s% customer satisfaction through excellence in product design, manufacturing and customer support. In addition to our standard line of products we can provide modifications and custom designs for OEM applications. Our engineering team is eager to satisfy any special requirements. Please contact us for further information or suggestions for improvement.*



*Force and torque measurement engineered better*

**Mark-10 Corporation**

11 Dixon Avenue  
Copiague, NY 11726 USA  
1-888-MARK-TEN  
Tel: 631-842-9200  
Fax: 631-842-9201  
Internet: [www.mark-10.com](http://www.mark-10.com)  
E-mail: [info@mark-10.com](mailto:info@mark-10.com)